

380-377 SUMMIT® PRO 1.28

MANSFIELD®

Round Front, Vitreous China, Two-Piece Toilet

FEATURES

- High performance MagnaFlush™ flushing technology
- SmartFasten™ 3-bolt tank-to-bowl connection
- 1.28 gpf / 4.8 lpf low water consumption
- Round front bowl
- PuraClean® easy-to-clean glaze
- Fluidmaster® pilot operated anti-siphon fill valve
- 3" Rigid Flapper flush valve – requires less force to flush, is more consistent and uses a simple universal repair part/seal
- Model 59 color match, metal trip lever
- 12" rough-in
- 2" glazed trapway
- The Mansfield® limited lifetime warranty on china, Five-year limited warranty on tank trim
- Available in White





MODEL 380-377

Toilet seat not included



ROUND

COMPONENTS

MODEL #	DESCRIPTION	CODES/STANDARDS
380-377	Round front, two-piece toilet. Less toilet seat and supply.	  
380	Round front toilet bowl only. Less toilet seat.	
377	Tank and cover only, with left hand, front-mount, color match, metal trip lever. Less supply.	
TANK TRIM & REPLACEMENT PARTS		
59	Trip lever - color match, metal trip lever, left hand	
2036-1212	Summit® 1.28 rigid flapper flush valve	
400A	Fluidmaster® pilot anti-siphon fill valve	
2206	Pilot operated fill valve	
630-0030	Replacement flush valve seal	
386-LID	Tank lid	





380-377 SUMMIT® PRO 1.28



Round Front, Vitreous China, Two-Piece Toilet

SPECIFICATIONS

MODEL #	DESCRIPTION	CODES/STANDARDS
380-377	Round front, (1.28 gpf/4.8 lpf) two-piece toilet	  

MATERIAL	Vitreous China
WATER PRESSURE RANGE	20 to 80 PSI
FLUSH SYSTEM	MagnaFlush™ flushing technology
WATER USAGE	1.28 gpf / 4.8 lpf
WATER SURFACE AREA	8' X 9'
ROUGH-IN	12'
MAP RATING	1,000 grams

TRAP DIAMETER	2'
TRAP SEAL	2-3/8'
SHIPPING WEIGHT	Model 380 - 49 lbs. (22.2 kg) Model 377 - 36 lbs. (16.3 kg)
WARRANTY	Vitreous China - Limited Lifetime Tank Trim - Limited Five Year

TANK OPTIONS	TECHNICAL INFORMATION
377RH Variation of model 377, with right hand trip lever.	Note: these dimensions are nominal and subject to change without notice.

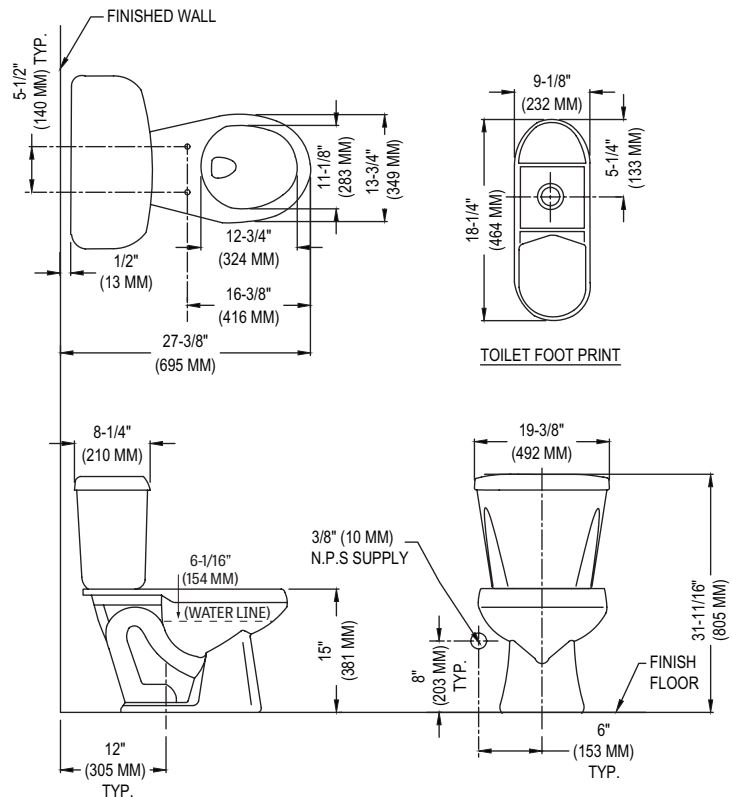

Fixture performance and specifications meet or exceed ASME A112.19.2-2013/CSA B45.1-13 standards, and other state and local codes.

