

Model 5367

Brentwood 60" x 32" x 19 1/4" Swirl-way® Air Massage Bath

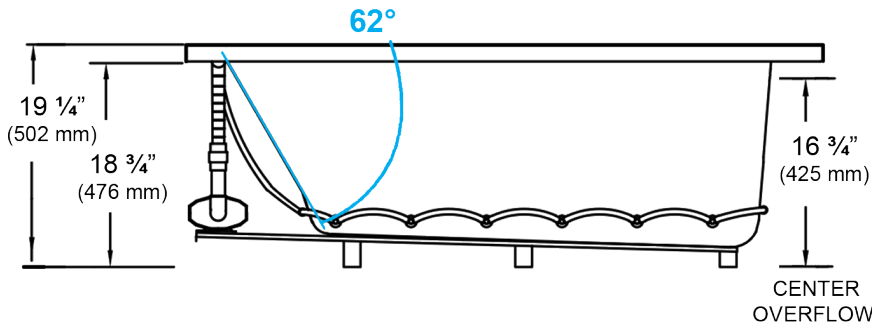
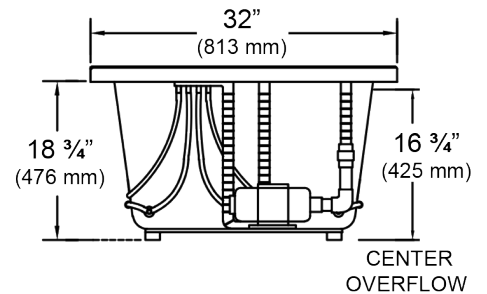
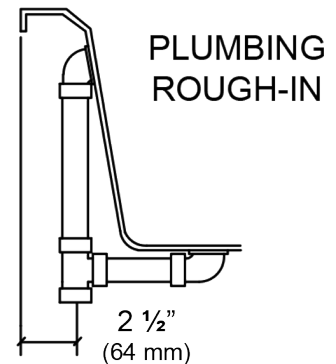
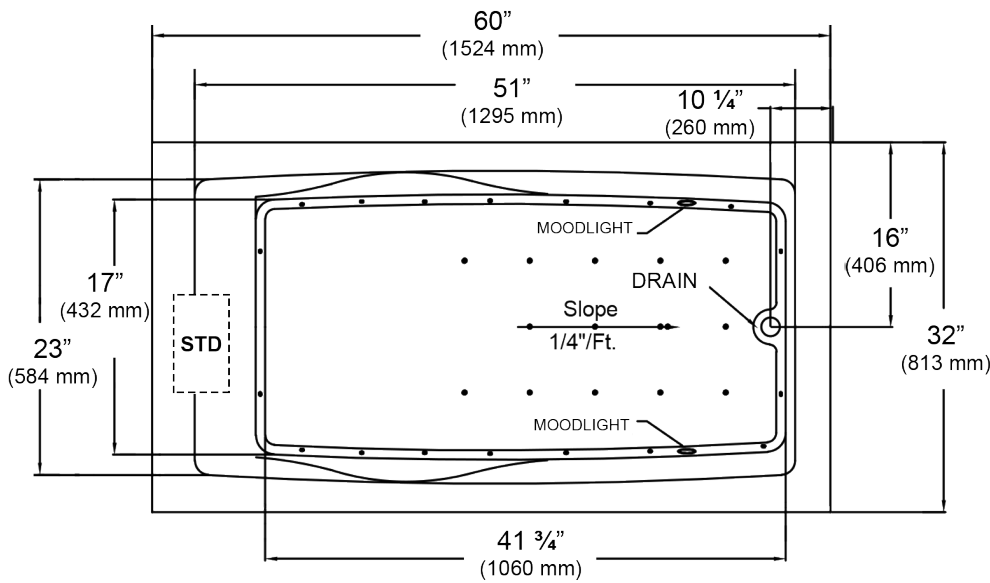

NOTES:

1. Blower location is shown for clarity.
2. Required blower motor access is 20" W x 15" H.
3. Measurements may vary 1/4" (+/-).
4. If a factory installed nailing flange is added to a unit, add 1/8" to each side flanged.
5. Optional removable apron is not available on this unit.
6. These dimensions are nominal and subject to change without notice.

SPECIFICATIONS

Specification	Description	Specification	Description
Material	Acrylic, fiberglass reinforced	Number of Jets	29
Construction	Self-contained, pre-plumbed air bath system mounted on a pre-leveled base	Water Capacity	40 gal. (min) 52 gal. (max)
Blower Motor	1.0 HP Variable Speed - 120 V, 9.0 AMP	Floor Loading Weight	47 lbs. / sq. ft (229 kg/m ²)
Electrical Requirements	One 120V, 20 AMP, GFCI Protected Circuit	Shipping Weight	130 lbs.
On/Off Control	Six button electronic control 20 minute time cycle, and auto purge cycle	Warranty	Limited Ten Year

