

Model 5258 Heathrow R

Swirl-way® Rectangular MicroDerm™ Therapeutic Bath



MicroDerm™ Therapeutic Bath Features





- 72" x 42" x 23" rectangular bathtub
- MicroDerm™ microbubble technology
- Sculpted armrests and lumbar backrest
- Two pillows
- Mansfield® Limited Ten Year Warranty
- Available in standard colors (white, bone, biscuit and almond) and premium colors* (British khaki, black and ice gray)

*additional charge will apply

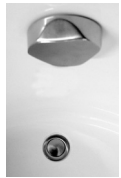

Model 5258

Options

Cable Drain			Lift and Turn Drain		
Model #	Description		Model #	Description	
SW1319	Standard Colors		PF1320	Polished Chrome	
SW1320	Polished Chrome		PF1321	Everbrass (PVD)	
SW1321	Everbrass (PVD)		PF1322	Brushed Nickel	
SW1322	Brushed Nickel		PF1323	Oil Rubbed Bronze	
SW1323	Oil Rubbed Bronze				
SWP150	Factory installed nailing flange		SWA100	Rainbow Pillow	
SWAP00	Nailing flange kit				

Trim

Model #	Description
-	Color-match trim included for standard colors
MD1335	Polished Chrome (for premium colors)



MADE IN USA

Model 5258 Heathrow R

Swirl-way® Rectangular MicroDerm™ Therapeutic Bath



Specifications

Model #	Description
5258	72" x 42" x 23" Rectangle

Specification	Description	Specification	Description
Material	Acrylic, fiberglass reinforced	Number of Jets	2
Construction	Self-contained, pre-plumbed bath system, mounted on a pre-leveled base	Water Capacity	60 gal. (min.) 72 gal. (max.)
Pump Motor	120V, 10 Amp, 60 Hz Thermally protected	Floor Loading Weight	47 lbs. / sq. ft. (229 kg / m ²)
Electrical Requirements	120V, 20 Amp, GFCI protected circuits	Shipping Weight	175 lbs.
On/Off Control	Single Button electronic control, 20-minute time cycle	Warranty	Limited Ten Year

Technical Information

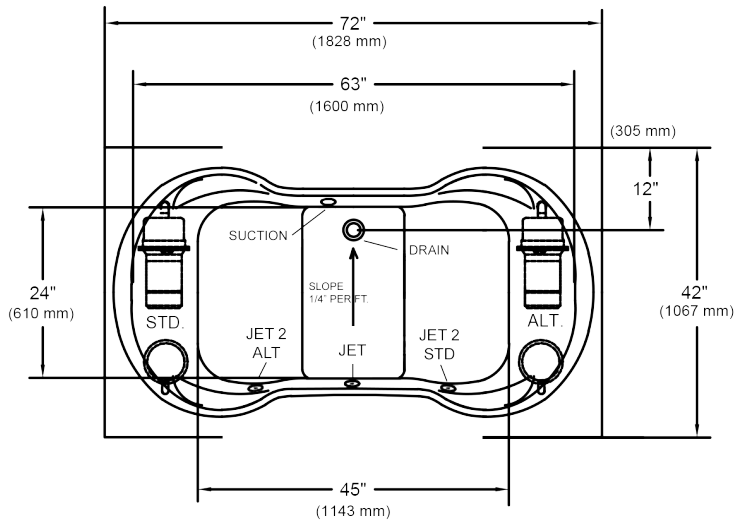

Pump location shown for clarity.
STD - Standard location ALT - Alternate location

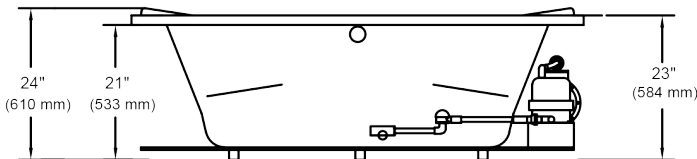

Rough-in measurements may vary 1/4" (+/-)

NO APRON AVAILABLE ON THIS MODEL

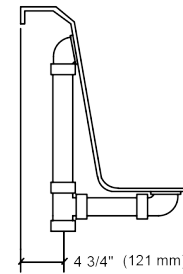

PLUMBING ROUGH-IN

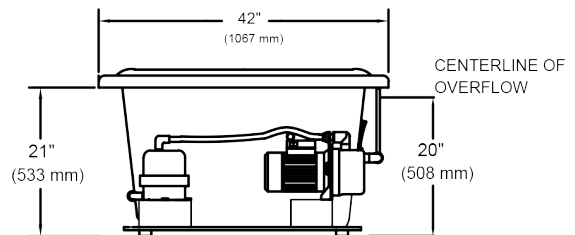

These dimensions are nominal and subject to change without notice.

When tested for compliance to the requirements of ASME A112.19.7M for "Whirlpool Bath Appliances" and ANSI Z124.1.2M "American National Standard for Plastic Bathtub and Shower Units", the tested units are found to comply and are acceptable for listing under IAPMO R & T.

Certified for permanent connection only.



MADE IN USA