

4380CTK SUMMIT® DUAL FLUSH

MANSFIELD®

Complete Toilet Kit, Round Front, Vitreous China, Two-Piece Toilet

FEATURES

- Complete toilet kit (CTK)
- Dual flush technology with 3" flush tower
- 1.1 Gpf / 1.6 Gpf (4.0 Lpf / 6.0 Lpf)
- Round front bowl
- SmartFasten™ 3-bolt tank-to-bowl connection
- PuraClean® easy-to-clean glaze
- Pilot operated anti-siphon fill valve
- 12" rough-in
- Model 33 chrome-plated push button actuator
- 2" glazed trapway
- The Mansfield® limited lifetime warranty
- Available in White, Biscuit and Bone



MODEL 4380CTK

Toilet seat included

Complete toilet kit





ROUND



CTK

COMPONENTS

MODEL #	DESCRIPTION	CODES/STANDARDS
4380CTK	Round front, two-piece toilet kit. Includes: toilet seat, wax toilet ring, floor bolts, caps, and multi-lingual installation instructions. Water supply hardware not included. Specify color.	  
380	Round front toilet bowl only. Less supply. Specify color.	
3386	Tank and cover only with chrome-plated push button actuator. Less supply. Specify color.	
3700	Round, slow close CTK seat	
TANK TRIM & REPLACEMENT PARTS		
33	Chrome-plated push button actuator	
2206	Pilot operated fill valve	
308	Dual flush tower	
3386-LID	Tank lid	





4380CTK SUMMIT® DUAL FLUSH



Complete Toilet Kit, Round Front, Vitreous China, Two-Piece Toilet

SPECIFICATIONS

MODEL #	DESCRIPTION	CODES/STANDARDS
4380CTK	Round front, (1.1 gpf/1.6 lpf) two-piece toilet kit	  

MATERIAL	Vitreous China
WATER PRESSURE RANGE	20 to 80 PSI
FLUSH SYSTEM	Dual flush with 3' flush tower
WATER USAGE	1.1 gpf / 1.6 lpf
WATER SURFACE AREA	8' X 9'
ROUGH-IN	12'
MAP RATING	800 grams

TRAP DIAMETER	2'
TRAP SEAL	2-3/8'
SHIPPING WEIGHT	Model 4380CTK - 91 lbs. (41.2 kg)
WARRANTY	Vitreous China - Limited Lifetime Tank Trim - Limited One Year

TECHNICAL INFORMATION

Note: these dimensions are nominal and subject to change without notice.

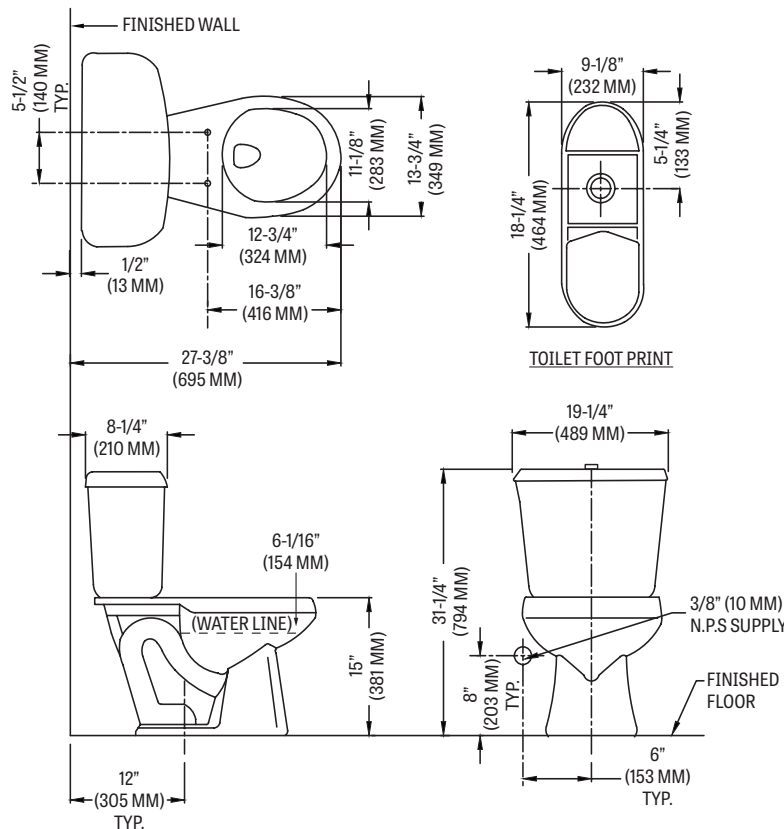

Fixture performance and specifications meet or exceed ASME A112.19.2-2013/CSA B45.1-13 standards, and other state and local codes.

