

384CTK SUMMIT®





Complete Toilet Kit, Elongated Front, SmartHeight™, Vitreous China, Two-Piece Toilet



FEATURES

- High performance MagnaFlush™ flushing technology
- Complete toilet kit (CTK)
- 1.6 gpf / 6.0 lpf
- Elongated front, SmartHeight™ bowl (ADA compliant)
- SmartFasten™ 3-bolt tank-to-bowl connection
- PuraClean® easy-to-clean glaze
- 3" Rigid Flapper flush valve – requires less force to flush, is more consistent and uses a simple universal repair part/seal
- Pilot operated anti-siphon fill valve
- 12" rough-in
- Model 57 chrome-plated, metal trip lever
- 2" glazed trapway
- The Mansfield® limited lifetime warranty on china; Five-year limited warranty on tank trim
- Available in White, Biscuit and Bone



MODEL 384CTK			
Toilet seat included	ELONGATED	SMARTHEIGHT ADA	CTK
Complete toilet kit			

COMPONENTS

MODEL #	DESCRIPTION	CODES/STANDARDS
384CTK	Elongated front, SmartHeight™, two-piece toilet kit. Includes: toilet seat, wax toilet ring, floor bolts, caps, and multi-lingual installation instructions. Water supply hardware not included. Specify color.	 
384	Elongated front, SmartHeight™ toilet bowl only. Less supply. Specify color.	
386	Tank and cover only, with left hand, front-mount, chrome-plated, metal trip lever. Less supply. Specify color.	
3800	Elongated, slow close CTk seat	

TANK TRIM & REPLACEMENT PARTS	
57	Trip lever - chrome-plated, metal trip lever, left hand
2037-1212	Summit® 1.6 rigid flapper flush valve
2206	Pilot operated fill valve
630-0030	Replacement flush valve seal
386-LID	Tank lid





384CTK SUMMIT[®]



Complete Toilet Kit, Elongated Front, SmartHeight™, Vitreous China, Two-Piece Toilet

SPECIFICATIONS

MODEL #	DESCRIPTION	CODES/STANDARDS
384-386	Elongated front, SmartHeight™ (1.6 gpf/6.0 lpf) two-piece toilet kit	 

MATERIAL	Vitreous China
WATER PRESSURE RANGE	20 to 80 PSI
FLUSH SYSTEM	MagnaFlush™ flushing technology
WATER USAGE	1.6 gpf / 6.0 lpf
WATER SURFACE AREA	9' X 10'
ROUGH-IN	12'
MAP RATING	1,000 grams

TRAP DIAMETER	2'
TRAP SEAL	2-3/8'
SHIPPING WEIGHT	Model 384CTK - 95 lbs. (43 kg)
WARRANTY	Vitreous China - Limited Lifetime Tank Trim - Limited Five Year

TECHNICAL INFORMATION

Note: these dimensions are nominal and subject to change without notice.

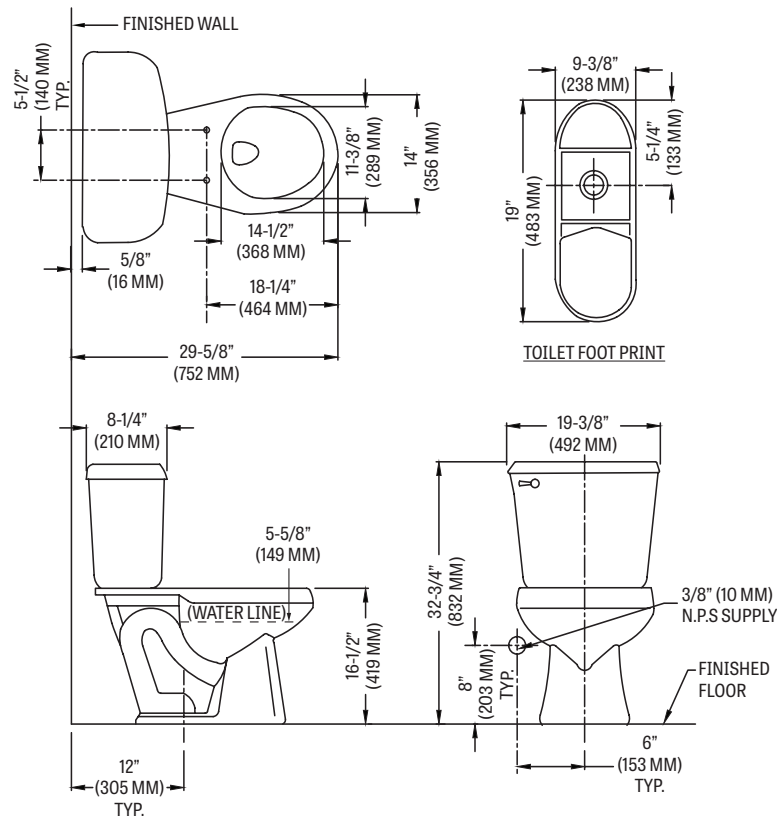

Fixture performance and specifications meet or exceed ASME A112.19.2-2013/CSA B45.1-13 standards, and other state and local codes.

