

149-153/154 QuantumOne™

Elongated Front, Rear Outlet, Floor Mount, Vitreous China, Two-Piece Toilet





Features

- Elongated, rear outlet, floor mount
- 1.0 gpf / 3.8 lpf ultra-low water consumption
- WaterSense™ certified (with 153 tank)
- High performance high efficiency (HET), pressure-assist, FlushMate IV™ technology
- Model 47 chrome plated push button actuator
- Also available with Model 45 left hand, chrome plated metal trip lever or Model 49 right hand, chrome plated metal trip lever
- 1-7/8" glazed trapway
- The Mansfield® limited lifetime warranty
- Available in White and Standard Colors: Biscuit and Bone





Model 149-154
Toilet seat not included

Components

Model #	Description	Codes/Standards
149-154	Elongated front, (1.0 gpf/3.8 lpf) rear outlet, pressure-assist, two-piece toilet. Includes tank trim and chrome plated, plastic push button actuator. Less toilet seat and supply. Specify color.	 
149	Elongated front, rear outlet toilet bowl only. Less toilet seat. Specify color.	
154	Pressure-assist tank and cover only with chrome plated plastic push button actuator. Less supply. Specify color.	
153RH	Same as model 153, except with right hand. trip lever.	

Other Options:

153	Same as model 154, except with left hand, chrome plated, metal trip lever.	  
-----	--	---





149-153/154 QuantumOne™

Elongated Front, Rear Outlet, Floor Mount, Vitreous China, Two-Piece Toilet



Specifications

Model #	Description	Codes/Standards
149-153/154	Elongated front two-piece toilet	 

Specification	Description	Specification	Description
Material	Vitreous China	Trap Diameter	1-7/8"
Water Pressure Range	35 to 80 PSI	Trap Seal	2-1/2"
Flush System	FlushMate IV™ Flushing Technology	Rough-in	Rear Outlet
Water Usage	1.0 gpf / 3.8 lpf	Shipping Weight	Model 149 - 60 lbs. (27.2 kg)
Water Surface Area	9-7/8" X 12-1/4"		Model 154/153/153RH - 41 lbs. (18.5 kg)
MaP Rating	1000 grams	Warranty	Vitreous China - Limited Lifetime Tank Trim - Limited One Year

Technical Information

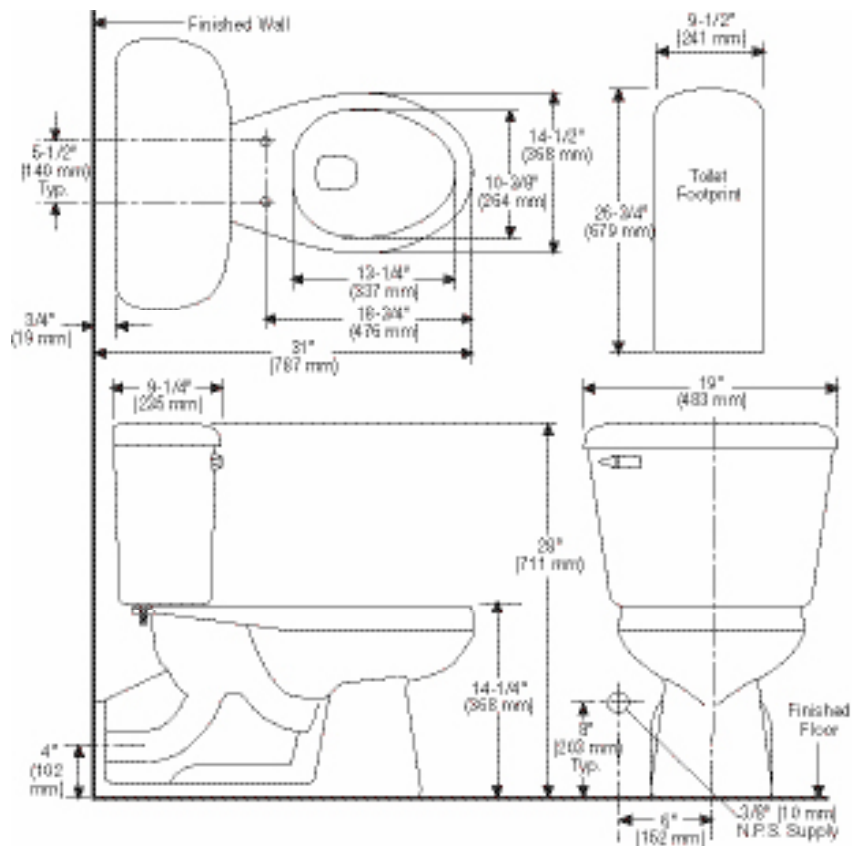

See our complete line of acrylic and vitreous china bathroom fixtures, plastic tank trim and plumbing products.

These dimensions are nominal and subject to change without notice.

Fixture performance and specifications meet or exceed ASME A112.19.2-2008/CSA B45.1-08 standards, and other state and local codes.



MADE IN USA