

Models 5093/5593

Enso®

Swirl-way® Oval Whirlpools and Bathtub



Bathtub and Whirlpool Features

- 72" x 36" x 22-1/4" oval bathtub
- Undermount or drop-in installation
- Two pillows
- Mansfield® Limited Ten Year Warranty
- Available in standard colors (white, almond, biscuit and bone) and premium colors (British khaki, sterling silver, black and ice gray)

Basic Whirlpool Features

- Hydro-V back jet system
- Single speed pump
- 1-button electronic keypad
- Color match trim
- Dual air controls

Luxury Whirlpool Features

- Hydro-V back jet system
- Variable speed pump
- 5-button electronic keypad with digital temperature readout
- Metal trim upgrades
- Chromotherapy system
- In-line heater





Model 5093BAS

Options



Cable Drain

Lift and Turn Drain

Model #	Description		Model #	Description	
SW1319	Standard Colors		PF1320	Polished Chrome	
SW1320	Polished Chrome		PF1321	Everbrass (PVD)	
SW1321	Everbrass (PVD)		PF1322	Brushed Nickel	
SW1322	Brushed Nickel		PF1323	Oil Rubbed Bronze	
SW1323	Oil Rubbed Bronze		SWA100	Rainbow Pillow	

Whirlpool Options

Metal Trim

Model #	Description		Model #	Description	
SW1335	Chrome		SWP151	In-line water heater	
SW1336	Everbrass (PVD)				
SW1337	Brushed Nickel				
SW1338	Oil Rubbed Bronze				



MADE IN USA



Models 5093/5593

Enso®

Swirl-way® Oval Whirlpools and Bathtub



Specifications

Model #	Description	Codes/Standards
5593	72" x 36" x 22-1/4" Oval bath.	  
5093BAS	72" x 36" x 22-1/4" Basic Whirlpool Package.	
5093LUX	72" x 36" x 22-1/4" Luxury Whirlpool Package.	

Specification	Description	Specification	Description
Material	Acrylic, fiberglass reinforced	Number of Jets	16
Construction	Self-contained, pre-plumbed whirlpool bath, with heat-bent rigid PVC pipe, mounted on a pre-leveled base	Water Capacity	37 gal. (min.) / 54 gal. (max.)
Pump Motor	Basic: 1.5 HP Single speed induction pump Luxury: 1.5 HP Variable speed induction pump	Floor Loading Weight	47 lbs. / sq. ft. (229 kg/m ²)
Electrical Requirements	Basic: One 120V, 20 Amp, GFCI dedicated circuit. Optional heater: separate 120V, 20 Amp, GFCI dedicated circuit. Luxury: Two separate 120V, 20 Amp, GFCI dedicated circuits.	Shipping Weight	bathtub - 150 lbs. whirlpool - 175 lbs.
On/Off Control	Basic: 1-button electronic control pad Luxury: 5-button electronic control pad with digital readout showing temperature of water, speed of pump and time remaining in 20-minute cycle.	Warranty	Limited Ten Year

Technical Information

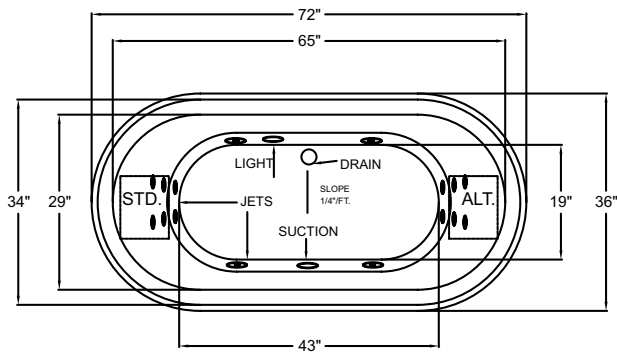

Pump locations shown for clarity.
STD - Standard Location ALT - Optional Alternate Location

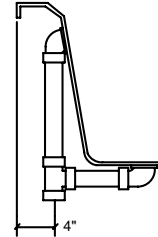
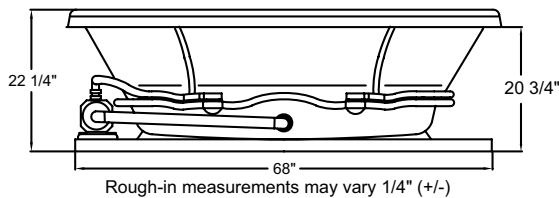

INSTALLER NOTE: DUE TO THE FREEFORM SHAPE OF THIS TUB IT IS RECOMMENDED THAT THE TUB BE ON THE JOBSITE BEFORE MAKING THE FINAL CUT OUT FOR DROP IN INSTALLATION.

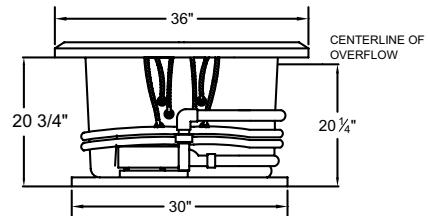

No apron available on this model.

Note: Install this product according to the installation guide.

These dimensions are nominal and subject to change without notice.

When tested for compliance to the requirements of ASME A112.19.7M for "Whirlpool Bath Appliances" and ANSI Z124.1.2M "American National Standard for Plastic Bathtub and Shower Units", the tested units are found to comply and are acceptable for listing under IAPMO R & T.

Certified for permanent electrical connection only.



MADE IN USA